



SPIRIT FITNESS
A Heritage of Quality | The Spirit of Innovation



XG400 Elliptical **OWNER'S MANUAL**

Please carefully read this entire manual before operating your new elliptical

TABLE OF CONTENTS

Product Registration	1
Important Safety Instructions	2
Important Electrical Instructions	3
Important Operation Instructions	4
XG400 Assembly Instructions	5
Features	11
Console Operation	13
Programmable Features	16
Using Heart Rate Transmitter	22
General Maintenance	24
Manufacturer's Limited Warranty	25

ATTENTION

This elliptical is intended for residential use only and is warranted for this application. Any other application voids this warranty in its entirety.



Congratulations on your new elliptical and welcome to the Spirit family!

Thank you for your purchase of this quality elliptical trainer from Spirit Manufacturing, Inc. Your new elliptical was manufactured by one of the leading fitness manufacturers in the world and is backed by one of the most comprehensive warranties available. Through your dealer, Spirit will do all we can to make your ownership experience as pleasant as possible for many years to come. If not purchased direct from Spirit, the local dealership where you purchased this elliptical is your administrator for all Spirit warranty and service needs. Their responsibility is to provide you with the technical knowledge and service personnel to make your experience more informed and any difficulties easier to remedy.

Please take a moment at this time to record the name of the dealer, their telephone number, and the date of purchase below to make any future, needed contact easy. We appreciate your support and we will always remember that you are the reason that we are in business. Please complete and mail your registration card today and enjoy your new elliptical trainer.

Yours in Health,
Spirit Manufacturing, Inc.

Name of Dealer _____
Dealer Phone # _____
Purchase Date _____

PRODUCT REGISTRATION

RECORD YOUR SERIAL NUMBER

Please record the Serial Number of this fitness product in the space provided below.

Serial Number _____

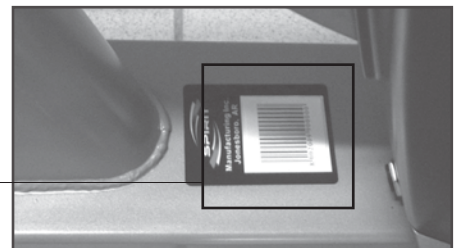

REGISTER YOUR PURCHASE

The self-addressed product registration card must be completed in full and returned to Spirit Manufacturing, Inc. You can also go to www.spiritfitness.com/warranty.asp under the support tab to register online.

IMPORTANT SAFETY INSTRUCTIONS

WARNING - Read all instructions before using this appliance.

DANGER - To reduce the risk of electric shock disconnect your Spirit elliptical from the electrical outlet prior to cleaning and/or service work.

WARNING - To reduce the risk of burns, fire, electric shock, or injury to persons, install the elliptical on a flat level surface with access to a 110-volt, 15-amp grounded outlet with only the elliptical plugged into the circuit.

DO NOT USE AN EXTENSION CORD UNLESS IT IS A 14AWG OR BETTER, WITH ONLY ONE OUTLET ON THE END:

- Do not operate elliptical on deeply padded, plush or shag carpet. Damage to both carpet and elliptical may result.
- Keep children away from the elliptical. There are obvious pinch points and other caution areas that can cause harm.
- Keep hands away from all moving parts.
- Never operate the elliptical if it has a damaged cord or plug. If the elliptical is not working properly, call your dealer.
- Keep the cord away from heated surfaces.
- Do not operate where aerosol spray products are being used or where oxygen is being administered. Sparks from the motor may ignite a highly gaseous environment.
- Never drop or insert any object into any openings.
- Do not use outdoors.
- To disconnect, turn all controls to the off position, then remove the plug from the outlet.
- Do not attempt to use your elliptical for any purpose other than for the purpose it is intended.
- The hand pulse sensors are not medical devices. Their purpose is to provide you with an approximate measurement in relation to your target heart rate. Use of a chest transmitter strap is a much more accurate method of heart rate analysis. Various factors, including the user's movement, may affect the accuracy of heart rate readings. The pulse sensors are intended only as exercise aids in determining heart rate trends in general.
- Wear proper shoes. High heels, dress shoes, sandals or bare feet are not suitable for use on your elliptical. Quality athletic shoes are recommended to avoid leg fatigue.

SAVE THESE INSTRUCTIONS - THINK SAFETY!

IMPORTANT ELECTRICAL INSTRUCTIONS

WARNING!

NEVER remove any cover without first disconnecting AC power. If voltage varies by ten percent (10%) or more, the performance of your elliptical may be affected. Such conditions are not covered under your warranty. If you suspect the voltage is low, contact your local power company or a licensed electrician for proper testing.

NEVER expose this elliptical to rain or moisture. This product is **NOT** designed for use outdoors, near a pool or spa, or in any other high humidity environment. The operating temperature specification is 40 to 120 degrees Fahrenheit, and humidity is 95% non-condensing (no water drops forming on surfaces).



POWER CONNECTOR - Middle of unit

IMPORTANT OPERATION INSTRUCTIONS

- **NEVER** operate this elliptical without reading and completely understanding the results of any operational change you request from the computer.
- Understand that changes in resistance do not occur immediately. Set your desired resistance level on the computer console and release the adjustment key. The computer will obey the command gradually.
- **NEVER** use your elliptical during an electrical storm. Surges may occur in your household power supply that could damage elliptical components. Unplug the elliptical during an electrical storm as a precaution.
- Use caution while participating in other activities while pedaling on your elliptical; such as watching television, reading, etc. These distractions may cause you to lose balance which may result in serious injury.
- Do not use excessive pressure on console control keys. They are precision set to function properly with little finger pressure.

XG400 ASSEMBLY INSTRUCTIONS

PRE-ASSEMBLY

1. Using a razor knife (Box Cutter), cut the banding straps that wrap around the carton. Reach under the bottom edge of the carton and pull it away from the cardboard underneath, separating the staples that join the two together. Lift the box over the unit and unpack.
2. Carefully remove all parts from carton and inspect for any damage or missing parts. If damaged parts are found, or parts are missing, contact your dealer immediately.
3. Locate the hardware package. The hardware is separated into four steps. Remove the tools first. Remove the hardware for each step as needed to avoid confusion. The numbers in the instructions that are in parenthesis (#) are the item number from the assembly drawing for reference.

ASSEMBLY TOOLS

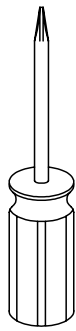

#107. Phillips Head
Screwdriver

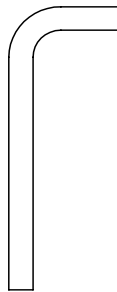

#108. 8mm Allen
Wrench

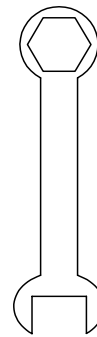

#109. 17mm
Wrench

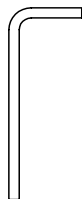

#110. 5mm Allen
Wrench

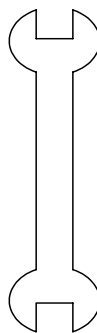

#111. 13/14mm
Wrench

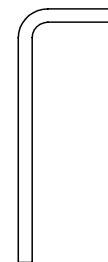

#116. 6mm Allen
Wrench

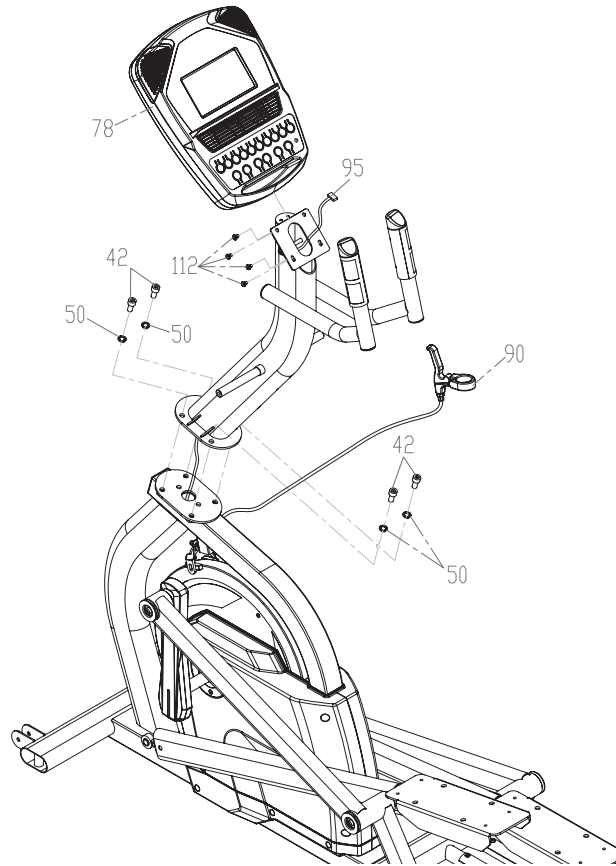

1 CONSOLE MAST

1. Feed the computer cable (95) up through the console mast tube (pulse grip posts at the top) with the end of the twist tie that is attached to it.
2. Place the console mast tube onto the mating plate of the main frame; Be careful not to pinch the Computer cable between the console mast and the main frame plates during assembly.
3. Secure the console mast in place with the four stainless steel bolts (42) and split washers (50). Make sure the bolts are securely tightened using the 8mm Allen wrench (108).
4. Attach the console (78) to the bracket with four Phillips Head Screws (112) using the Phillips Head Screw Driver (107).
5. Attach the hand brake lever (90) to the handlebars as follows:
 - Remove the screw that is threaded into the nut on the backside of the hand brake with the Phillips head screw driver (107)
 - Place the hand brake bracket around the front of the right handlebar vertical tube, then insert the bolt through the back of the bracket and thread back into the nut. Tighten with the Phillips head screw driver (107)

HARDWARE

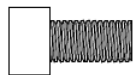

#42. M10 x 20mm
Stainless Steel Bolt
(4 pcs)



#50. M10
Split Washer
(4 pcs)



#112. M5 x 12mm
Phillips Head Screw
(4 pcs)

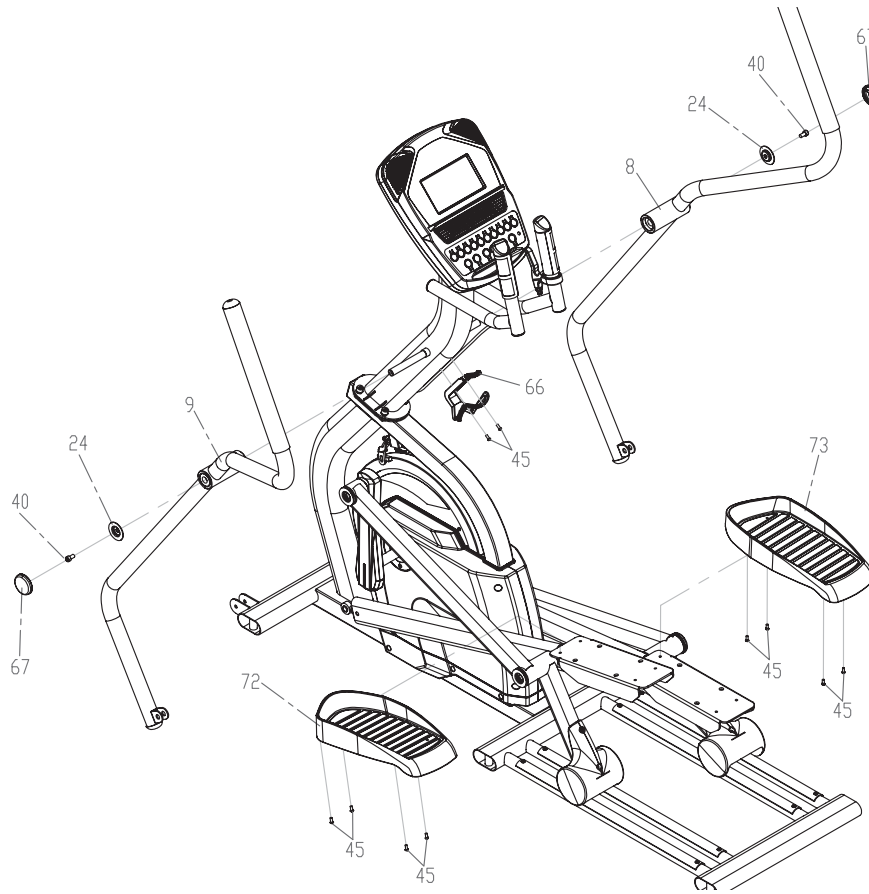

2 SWING ARMS & PEDALS

1. Remove the foam from the console mast axles and the plastic ties from the tubes that slide onto the console mast axles.
2. Slide the two swing arms (**8 Right & 9 Left**) onto the console mast axle. There is a left and right swing arm (marked with an “R” and an “L”) so make sure you assemble the correct one on each side. Do not force the arms onto the axle or use a hammer, as damage to the bearings could occur. The swing arms have been previously installed at the factory and should fit properly, although it is a snug fit.
3. Secure the swing arms in place with the stainless steel bolts (**40**; flat side of washers should be on the outside) and cup washers (**24**) and tighten with the wrench (**116**). Snap the decorative caps (**67**) over the cup washers.
4. Install the foot pedals (**72 Left & 73 Right**) with eight Phillips head screws (**45**) and tighten with the Phillips head screw driver (**107**). The pedals are identified with an L or R on the bottom.
5. Attach the water bottle holder (**66**) to the console mast tube with two Phillips Head Screws (**45**). Place the brake cable (**90**) behind the holder to keep it out of the way of operation. Tighten the screws with the Phillips Head Screw Driver (**107**)

HARDWARE



#24. Cup Washer
(2 pcs)



#40. M8 x 15mm
Stainless Steel Bolt
(2 pcs)



#45. M5 x 10mm
Phillips Screw
(10 pcs)

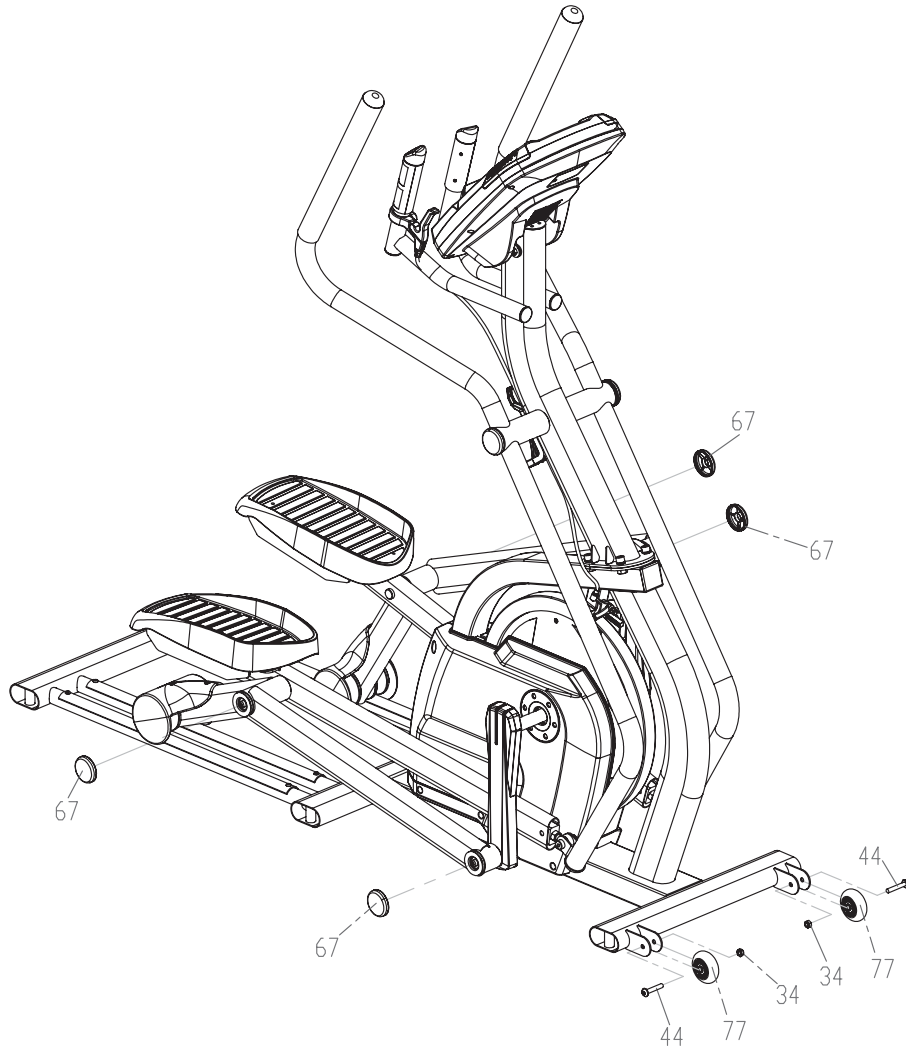

3 CAPS & WHEELS

1. Attach the transport wheels (77) to each bracket with the two bolts (44) and nuts (34). Partially tighten with the wrenches provided (110 & 111). Over tightening the hardware won't allow the wheels to rotate.
2. Snap the four end caps (67) onto the cup washers on the left & right pedal arm assemblies.

HARDWARE

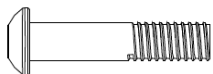

#44. 5/16" x 1-3/4"
Bolt
(2 pcs)



#34. 5/16"
Nut
(2 pcs)

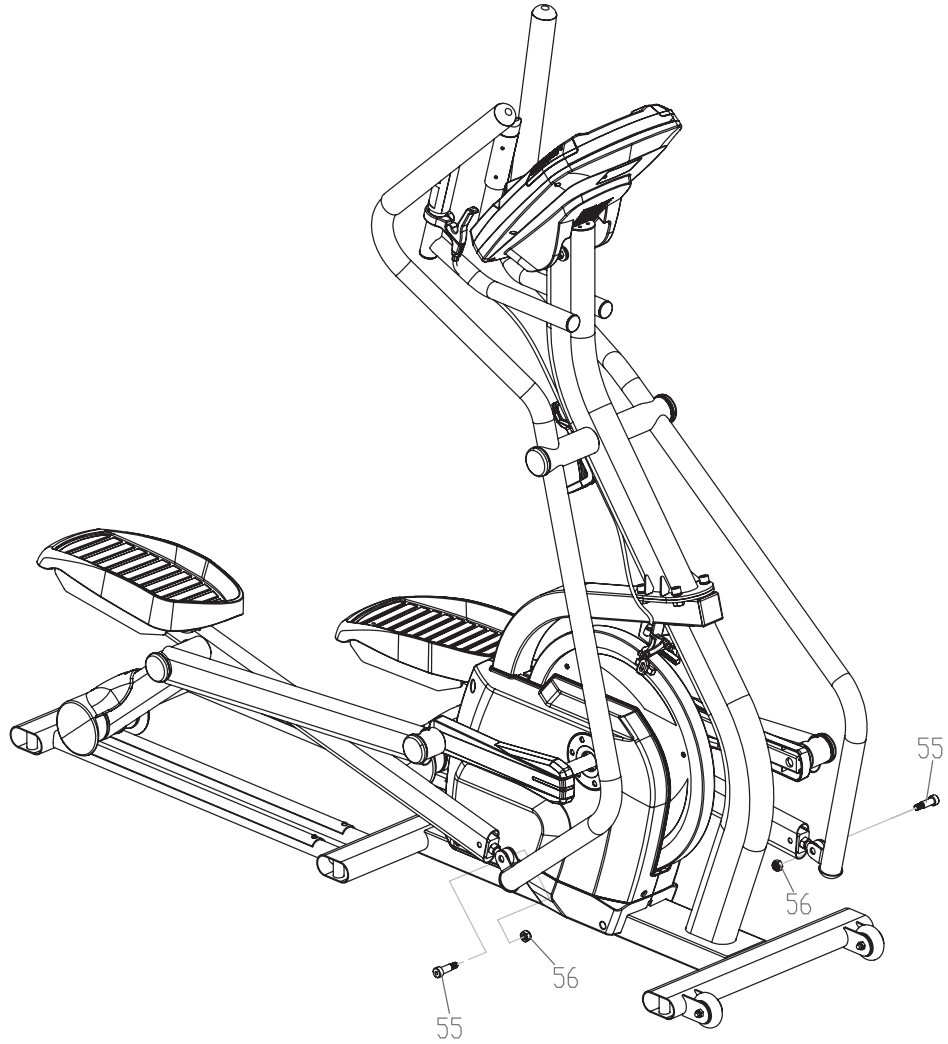

4 ARM ATTACHMENTS

1. Assemble the brackets at the bottom of the swing arms to the pedal arms using a shoulder bolt (**55**) and a nut (**56**) on each side. Tighten securely with the wrenches provided (**109 & 116**).

HARDWARE

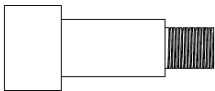

#55. M10 x 20mm
Shoulder Bolt
(2 pcs)



#56. M10
Nut
(2 pcs)

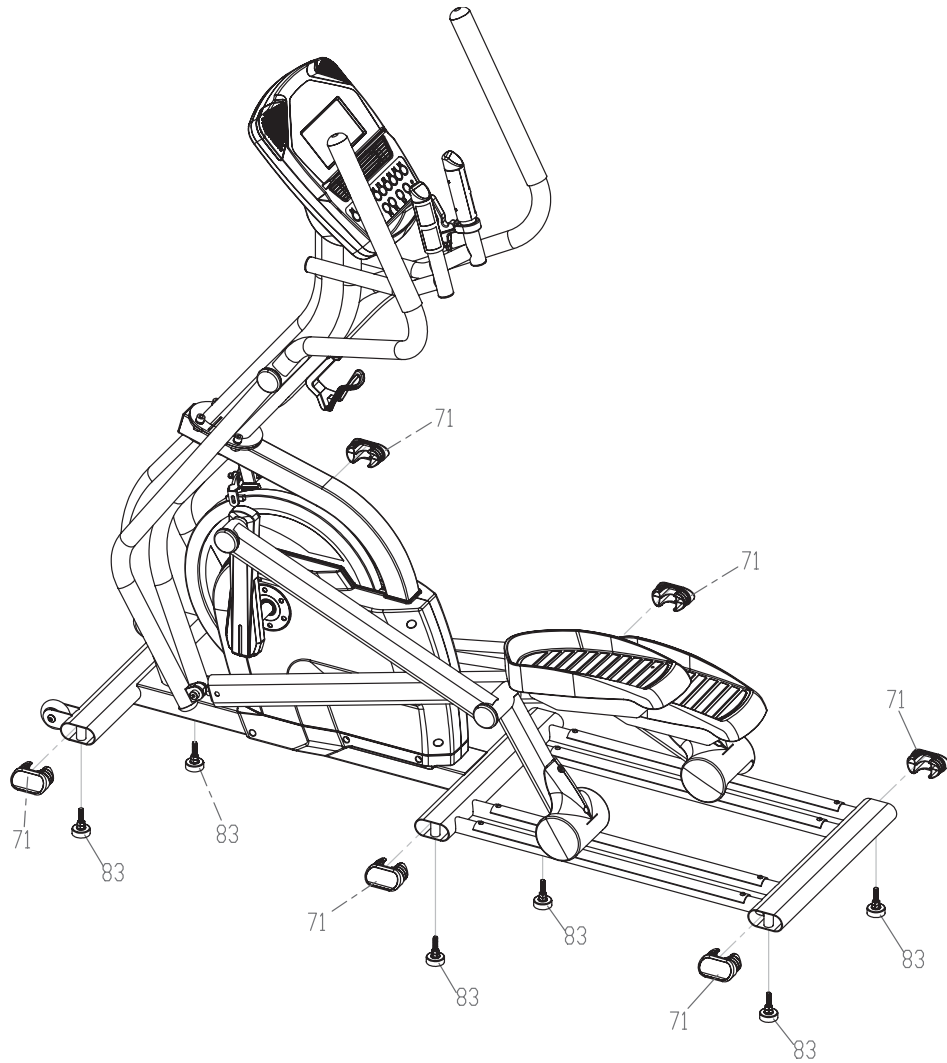

5 LEVELERS & END CAPS

1. Tilt the elliptical to one side and put something under the unit for support and install the three levelers (**83**) for that side. Tilt the unit to the other side and install those three levelers (**83**). Level the elliptical once it is positioned where it will be used. Screw the two middle levelers all the way in and the front and rear levelers all the way in, then back them out about two or three turns. Level the unit using only the front and rear levelers first, then adjust the middle levelers so they touch the floor. Make sure to lock the levelers when finished.
2. Press the six plastic end caps (**71**) into the oval stabilizer tubes.
3. Unlock the black lever located near the flywheel at the end of the brake cable (**90**). This is locked for shipping purposes, but also serves as a safety lock mechanism to prevent unauthorized use of this machine.

FEATURES

Here are the top reasons why we believe this Spirit elliptical trainer is among the best elliptical machines available for everyone:

- **State of the Art** patent-pending, industry-leading, super-smooth, super-fast elliptical motion that opens up vast new possibilities for riders to vary their workouts, by duration, intensity, frequency and personal goals, whether health, fitness, endurance, strength, or professional athletic.
- **Safety** features include an emergency hand brake and a manual lever to lock the flywheel when not in use.
- Thirty pound **Steel Flywheel**, along with a patented transmission system, provides the perfect amount of inertia that both challenges the rider, and assists in maintaining a smooth and even ride at every cadence.
- **Powerful Magnetic Resistance** provides super smooth, abundant resistance for high intensity workouts, ride variation, and larger riders.
- **Generous Footpads** allow precise foot placement both fore-aft and inside-out, and remain in a basic horizontal orientation throughout the elliptical stride, eliminating undesirable tipping forward of the feet.
- **Center-Mounted** fixed hand grips facilitate mounting and dismounting, in-ride recovery, and controlled sprints and interval training.
- **Essential Data** of RPM, Calories, Time (elapsed or countdown), Distance, Pulse, Level, Speed, Watts, Segment time countdown, and Laps completed are displayed on the digital LCD console.
- **Enhanced Movability** with a rear mounted hand grip, front-mounted heavy duty casters, and a narrower footprint.

HEART RATE BAR GRAPH

The console LCD screen will display your current heart rate anytime a pulse is detected. The Bar Graph, located right of the LCD screen, will show your current heart rate % in relation to your projected maximum heart rate, which is determined by your age that you entered during the programming phase of any of the 10 programs. The significance of the bar graph colors are as follows:

- 50-60% of maximum is Amber
- 65-80% of maximum is Amber and Green
- 85-90% or more is Amber, Green, and Red

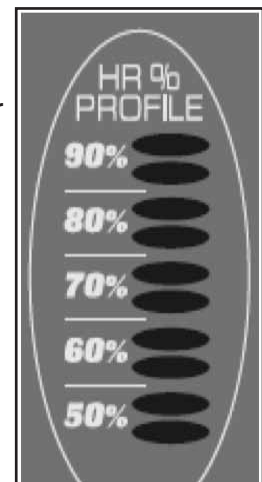

CONSOLE

MUSCLE ACTIVATION FIGURE

There is an anatomical figure located at the top of the console. This figure will light all areas that are activated when using the elliptical trainer. These will light up during any of the programs. You can control which muscles are activated by changing up the pedal pattern or switching your hand position during the manual program.

Generally the following guidelines hold true:

- The upper body lights will activate when you are either holding onto the swing arms or at anytime yours hands aren't holding onto the pulse grip sensors
- The lower body lights will activate in three degrees of engagement: Green represents minimal muscle involvement, Amber represents medium involvement, and Red represents full or heavy activation.
- These are the different scenarios for lower body muscle activation
 - Forward pedal rotation
 - Gluteals & Quadriceps are Amber;
 - Hamstrings & Calves are Green
 - Reverse pedal rotation
 - Incline: Calves, Hamstrings, and Quadriceps are Amber; Gluteals are Green



OPERATION OF YOUR CONSOLE

GETTING FAMILIAR WITH THE CONTROL PANEL

XG400 CONSOLE



POWER UP

When the A.C. power cord is connected to the Elliptical, the console will automatically power up. If there is no input to the console for 20 minutes the console will go to stand-by mode. In stand-by mode the console display will turn off. To turn the console on press any key.

When initially powered on the console will perform an internal self-test. During this time all the lights will turn on. When the lights go off, the **Message Center** will show the software version (i.e.: VER 1.0). The distance window shows the distance in miles and the time window shows the total hours of use.

The odometer will remain displayed for only a few seconds then the console will go to the start up display. The dot matrix display will be scrolling through the different profiles of the programs and the **Message Center** will be scrolling the start up message. You may now begin to use the console.

QUICK START

This is the quickest way to start a workout. After the console powers up you just press the **Start** key to begin, this will initiate the Quick Start mode. In Quick Start the Time will count up from zero and the workload may be adjusted manually by pressing the Level Up or Down buttons. The dot matrix display will have only the bottom row lit at first. As you increase the work load more rows will light indicating a harder workout. The elliptical will get harder to pedal as the rows increase.



There are 20 levels of resistance available for plenty of variety. The first 5 levels are very easy workloads and the changes between levels are set to a good progression for de-conditioned users. Levels 6-10 are more challenging, but the increases in resistance from one level to the next remain small. Levels 11-15 start getting tough as the levels jump more dramatically. Levels 16-20 are extremely hard and are good for short interval peaks and elite athletic training.

BASIC INFORMATION

The **Message Center** will initially be displaying the Program name. When in scan mode during a program, speed will be displayed for four seconds, then move on and display Watts (indication of workload). If 100 watts is displayed, you are doing enough work to keep a 100-watt light bulb lit. The data changes to Laps completed, Segment time, Max level. Pressing the **Enter** button again will bring you back to the beginning.



The **Stop** button actually has several functions. Pressing the **Stop** key once during a program will **Pause** the program for 5 minutes. If you need to get a drink, answer the phone or any of the many things that could interrupt your workout, this is a great feature. To resume your workout during **Pause**, just press the **Start** key. If the **Stop** button is pressed twice during a workout, the program will end and the console will display your Workout Summary (Total time, Avg. Speed, Avg. Watts, Avg. HR, total Laps). If the **Stop** key is held down for 3 seconds or a third time during the program, the console will perform a complete **Reset**. During data entry for a program the **Stop** key performs a **Previous Screen or segment** function. This allows you to go back to change programming data.



PROGRAM KEYS

The **Program Keys** are used to preview each program. When you first turn the console on you may press each program key to preview what the program profile looks like. If you decide that you want to try a program, press the corresponding program key and then press the **Enter** key to select the program and enter into the data-setting mode.

The elliptical has a built in heart rate monitoring system. Simply grasping the hand pulse sensors on the stationary handle bars or wearing the heart rate transmitter (see Using Heart Rate Transmitter section) will start the **Heart Icon** blinking (this may take a few seconds). The **Pulse Display Window** will display your heart rate, or Pulse in beats per minute.

The consoles include a built-in fan to help keep you cool. To turn the fan on, press the button on the left side of the console.

PROGRAMMING THE CONSOLE

Each of the programs can be customized with your personal information and changed to suit your needs. Some of the information asked for is necessary to ensure the readouts are correct. You will be asked for your Age and Weight. Entering your Age is necessary during the Heart Rate programs to ensure the correct settings are in the program for your Age. Otherwise the work settings could be too high or low for you. Entering your Weight aides in calculating a more correct Calorie reading. Although we cannot provide an exact calorie count, we do want to be as close as possible.

CALORIE NOTE: Calorie readings on every piece of exercise equipment, whether it is in a gym or at home, are not accurate and tend to vary widely. They are meant only as a guide to monitor your progress from workout to workout. The only way to measure your calorie burn accurately is in a clinical setting connected to a host of machines. This is because every person is different and burns calories at a different rate. Some good news is that you will continue to burn calories at an accelerated rate for at least an hour after you have finished exercising!

ENTERING A PROGRAM AND CHANGING SETTINGS

When you enter a program, by pressing a program key, then **Enter** key, you have the option of entering your own personal settings. If you want to workout without entering new settings, then just press the **Start** key. This will bypass the programming of data and take you directly to the start of your workout. If you want to change the personal settings then just follow the instructions in the **Message Center**. If you start a program without changing the settings, the default or saved settings will be used.

NOTE: Age and Weight default settings will change when you enter a new number. So the last Age and Weight entered will be saved as the new default settings. If you enter your Age and Weight the first time you use the elliptical, you will not have to enter it every time you work out unless either your Age or Weight changes, or someone else enters a different Age and Weight.

PROGRAMMABLE FEATURES

MANUAL

The Manual program works as the name implies, manually. This means that you control the workload and not the computer. To start the Manual program, follow the instructions below or just press the Manual button, then the **Enter** button and follow the directions in the **Message Center**.

1. Press the Manual key, then press the **Enter** key.
2. The **Message Center** will ask you to enter your **Age**. You may enter your age, using the Up and Down keys, then press the **Enter** key to accept the new value and proceed on to the next screen.
3. You are now asked to enter your **Weight**. You may adjust the **Weight** value using the Up and Down keys, then press **Enter** to continue.
4. Next is **Time**. You may adjust the **Time** and press **Enter** to continue.
5. Now you are finished editing the settings and can begin your workout by pressing the **Start** key. You can also go back and modify your settings by pressing the **Stop** key. NOTE: At any time during the editing of Data you can press the **Stop** key to go back one level, or screen.
6. Once the program starts you will be at level one. This is the easiest level and it is a good idea to stay at level one for a while to warm up. If you want to increase the work load at any time press the Up key; the Down key will decrease the work-load.
7. During the Manual program you will be able to scroll through the data in the **Message Center** by pressing the **Enter** key.
8. When the program ends you may press **Start** to begin the same program again or **Stop** to exit the program or you can save the program you just completed as a custom user program by pressing a User key and following the instructions in the **Message Center**.

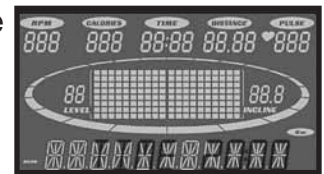
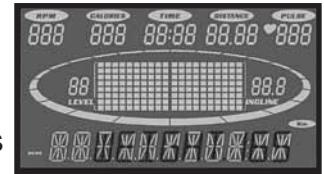
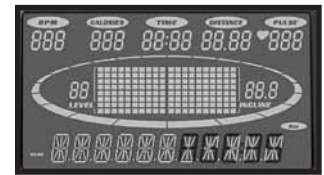

PRESET PROGRAMS

The elliptical has five different programs that have been designed for a variety of workouts. These five programs have factory preset work level profiles for achieving different goals.

Hill

This program follows a triangle or pyramid type of gradual progression from approximately 10% of maximum effort (the level that you chose before starting this program) up to a maximum effort which lasts for 10% of the total workout time, then a gradual regression of resistance back to approximately 10% of maximum effort.

XG400 RESISTANCE

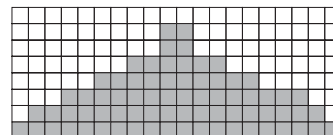

Fat Burn

This program follows a quick progression up to the maximum resistance level (default or user input level) that is sustained for 2/3 of the workout. This program will challenge your ability to sustain your energy output for an extended period of time.

XG400 RESISTANCE

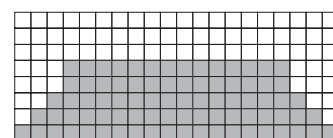

Cardio

This program presents a quick progression up to near maximum resistance level (default or user input level). It has slight fluctuations up and down to allow your heart rate to elevate, and then recover repeatedly, before beginning a quick cool down. This will build up your heart muscle and increase blood flow and lung capacity.

XG400 RESISTANCE

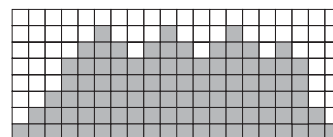

Strength

This program has a gradual progression of resistance up to 100% of maximum effort that is sustained for 25% of workout duration. This will help build strength and muscular endurance in the lower body and glutes. A brief cool down follows.

XG400 RESISTANCE

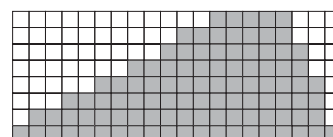

Interval

This program takes you through high levels of intensity followed by recovery periods of low intensity. This program utilizes and develops your “Fast Twitch” muscle fibers which are used when performing tasks that are intense and short in duration. These deplete your oxygen level and spike your heart rate, followed by periods of recovery and heart rate drop to replenish oxygen. Your cardiovascular system gets programmed to use oxygen more efficiently.

XG400 RESISTANCE

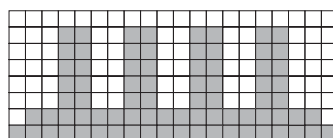

PROGRAMMING PRESET PROGRAMS

1. Select the desired program button then press the **Enter** key.
2. The **Message Center** will ask you to enter your **Age**. You may adjust the age setting, using the Level Up and Down keys, then press the Enter key to accept the new number and proceed on to the next screen.
3. You are now asked to enter your **Weight**. You may adjust the Weight value using the Level Up and Down keys, then press **Enter** to continue.
4. Next is **Time**. You may adjust the time and press enter to continue.
5. Now you are asked to adjust the **Max Resistance Level**. This is the peak exertion level you will experience during the program. Adjust the level and then press **Enter**.
6. Now you are finished editing the settings and can begin your workout by pressing the **Start** key. You can also go back and modify your settings by pressing the **Enter** key.
7. If you want to increase or decrease the resistance at any time during the program, press the Level Up or Down keys on the console or above the heart rate sensor grips of the stationary handlebars. This will change the resistance settings of the entire profile, although the profile picture on the screen will not change. The reason for this is so that you can see the entire profile at all times. If the profile picture is changed, it also would be distorted and not a true representation of the actual profile. When you make a change to the resistance, the **Message Center** will show the current column and program maximum levels of work.
8. During the program you will be able to scroll through the data in the message window by pressing the **Enter** key.
9. When the program ends the **Message Center** will show a summary of your workout. The summary will be displayed for a short time, then the console will return to the start-up display.

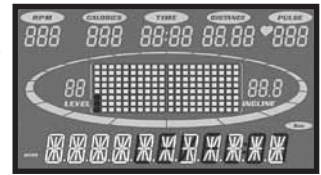
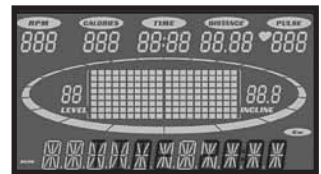
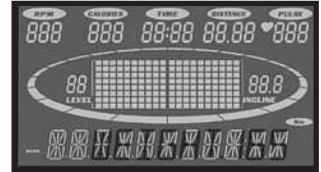
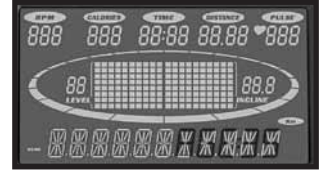

CUSTOM USER DEFINED PROGRAMS

There are two customizable **User** programs that allow you to build and save your own workout. The two programs, **User 1** and **User 2**, operate exactly the same way so there is no reason to describe them separately. You can build your own custom program by following the instructions below or you can save any other preset program you complete as a custom program. Both programs allow you to further personalize it by adding your name.

1. Press the **User 1** or **User 2** key. The **Message Center** will show a welcome message. If you had previously saved a program the message will contain your name. Then press the **Enter** key to begin programming.
2. When you press **Enter**, the **Message Center** will show “Name - A”, if there is no name saved. If the name “David” had been previously saved the **Message Center** will show “Name - David” and the D will be blinking. If there is a name saved you can change it or you may press the **Stop** key to keep the name and continue to the next step. If you want to enter a name use the **Up** and/or the **Down** key to change the first letter then press **Enter** to save the first letter and continue to the next letter. When you have finished entering the name press the **Stop** key to save the name and continue to the next step.
3. The **Message Center** will ask you to enter your **Age**. You may enter your age, using the **Level Up** and **Down** keys, then press the **Enter** key to accept the new value and proceed on to the next screen.
4. You are now asked to enter your **Weight**. You may adjust the weight value using the **Up** and **Down** keys or the numeric key pad, then press **Enter** to continue.
5. Next is **Time**. You may adjust the time and press **Enter** to continue.
6. Now you are asked to adjust the **Max Resistance Level** of the program, press **Enter** when resistance has been selected.
7. Now the first column will be blinking and you are asked to adjust the resistance level for the first segment(SEGMENT > 1) of the workout by using the **Level Up** key. When you finish adjusting the first segment, or if you don't want to change, then press **Enter** to continue to the next segment.
8. The next segment will show the same workload resistance level as the previously adjusted segment. Repeat the same process as the last segment then press enter. Continue this process until all twenty segments have been set.
9. The **Message Center** will then tell you to press **Enter** to save the program. After saving the program the **Message Center** says “New program saved” then will give you the option to **Start** or modify the program. Pressing **Stop** will exit to the start up screen.

HEART RATE PROGRAMS

The old motto, “no pain, no gain”, is a myth that has been overpowered by the benefits of exercising comfortably. A great deal of this success has been promoted by the use of heart rate monitors. With the proper use of a heart rate monitor, many people find that their usual choice of exercise intensity was either too high or too low and exercise is much more enjoyable by maintaining their heart rate in the desired benefit range.

To determine the benefit range in which you wish to train, you must first determine your Maximum Heart Rate. This can be accomplished by using the following formula: 220 minus your age. This will give you the Maximum Heart Rate (MHR) for someone of your age. To determine the effective heart rate range for specific goals you simply calculate a percentage of your MHR. Your Heart rate training zone is 50% to 90% of your maximum heart rate. 60% of your MHR is the zone that burns fat while 80% is for strengthening the cardio vascular system. This 60% to 80% is the zone to stay in for maximum benefit.

For someone who is 40 years old their target heart rate zone is calculated:

$$220 - 40 = 180 \text{ (maximum heart rate)}$$

$$180 \times .6 = 108 \text{ beats per minute} \\ \text{(60\% of maximum)}$$

$$180 \times .8 = 144 \text{ beats per minute} \\ \text{(80\% of maximum)}$$

So for a 40 year old the training zone would be 108 to 144 beats per minute.

If you enter your age during programming the console will perform this calculation automatically. Entering your age is used for the Heart Rate programs. After calculating your MHR you can decide upon which goal you would like to pursue.

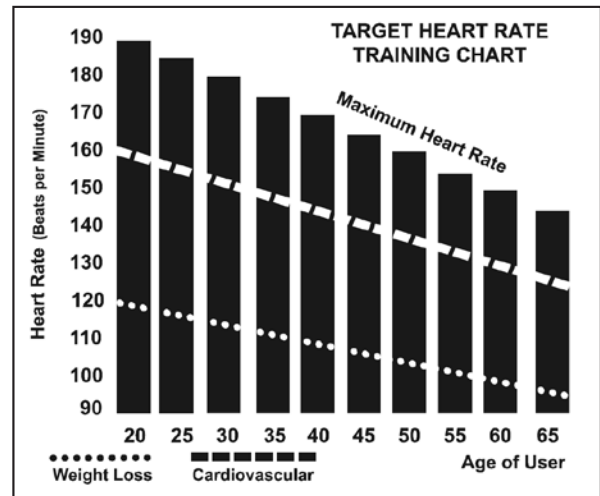

The two most popular reasons for, or goals, of exercise are cardiovascular fitness (training for the heart and lungs) and weight control. The black columns on the chart above represent the MHR for a person whose age is listed at the bottom of each column. The training heart rate, for either cardiovascular fitness or weight loss, is represented by two different lines that cut diagonally through the chart. A definition of the lines' goal is in the bottom left-hand corner of the chart. If your goal is cardiovascular fitness or if it is weight loss, it can be achieved by training at 80% or 60%, respectively, of your MHR on a schedule approved by your physician. Consult your physician before participating in any exercise program.

With all Spirit Heart Rate program elliptical machines you may use the heart rate monitor feature without using the Heart Rate program. This function can be used during manual mode or during any of the nine different programs. The Heart Rate program automatically controls resistance at the pedals.

RATE OF PERCEIVED EXERTION

Heart rate is important but listening to your body also has a lot of advantages. There are more variables involved in how hard you should workout than just heart rate. Your stress level, physical health, emotional health, temperature, humidity, the time of day, the last time you ate and what you ate, all contribute to the intensity at which you should workout. If you listen to your body, it will tell you all of these things.

The rate of perceived exertion (RPE), also know as the Borg scale, was developed by Swedish physiologist G.A.V. Borg. This scale rates exercise intensity from 6 to 20 depending upon how you feel or the perception of your effort.

The scale is as follows:

Rating Perception of Effort

- 6 Minimal
- 7 Very,very light
- 8 Very,very light +
- 9 Very light
- 10 Very light +
- 11 Fairly light
- 12 Comfortable
- 13 Somewhat hard
- 14 Somewhat hard +
- 15 Hard
- 16 Hard +
- 17 Very hard
- 18 Very hard +
- 19 Very,very hard
- 20 Maximal

You can get an approximate heart rate level for each rating by simply adding a zero to each rating. For example a rating of 12 will result in an approximate heart rate of 120 beats per minute. Your RPE will vary depending up the factors discussed earlier. That is the major benefit of this type of training. If your body is strong and rested, you will feel strong and your pace will feel easier. When your body is in this condition, you are able to train harder and the RPE will support this. If you are feeling tired and sluggish, it is because your body needs a break. In this condition, your pace will feel harder. Again, this will show up in your RPE and you will train at the proper level for that day.

USING HEART RATE TRANSMITTER

How to wear your wireless chest strap transmitter:

1. Attach the transmitter to the elastic strap using the locking parts.
2. Adjust the strap as tightly as possible as long as the strap is not too tight to remain comfortable.
3. Position the transmitter with the logo centered in the middle of your torso facing away from your chest (some people must position the transmitter slightly left of center). Attach the final end of the elastic strap by inserting the round end and, using the locking parts, secure the transmitter and strap around your chest.
4. Position the transmitter directly below the pectoral muscles.
5. Sweat is the best conductor to measure very minute heart beat electrical signals. However, plain water can also be used to pre-wet the electrodes (2 ribbed oval areas on the reverse side of the belt and both sides of the transmitter). It's also recommended that you wear the transmitter strap a few minutes before your work out. Some users, because of body chemistry, have a more difficult time in achieving a strong, steady signal at the beginning. After "warming up", this problem lessens. As noted, wearing clothing over the transmitter/strap doesn't affect performance.
6. Your workout must be within range - distance between transmitter/receiver - to achieve a strong steady signal. The length of range may vary somewhat but generally stay close enough to the console to maintain good, strong, reliable readings. Wearing the transmitter directly on bare skin assures you of proper operation. If you wish, you may wear the transmitter over a shirt. To do so, wet the areas of the shirt that the electrodes will rest upon.



Note: The transmitter is automatically activated when it detects activity from the user's heart. Additionally, it automatically deactivates when it does not receive any activity. Although the transmitter is water resistant, moisture can have the effect of creating false signals, so you should take precautions to completely dry the transmitter after use to prolong battery life (estimated transmitter battery life is 2500 hours). The replacement battery is Panasonic CR2032.

ERRATIC OPERATION

Caution! Do not use this elliptical for Heart Rate programs unless a steady, solid Actual Heart Rate value is being displayed. High, wild, random numbers being displayed indicate a problem.

Areas to look for interference which may cause erratic heart rate:

1. Microwave ovens, TV's, small appliances, etc.
2. Fluorescent lights.
3. Some household security systems.
4. Perimeter fence for a pet.
5. Some people have problems with the transmitter picking up a signal from their skin. If you have problems try wearing the transmitter upside down. Normally the transmitter will be oriented so the SPIRIT logo is right side up.
6. The antenna that picks up your heart rate is very sensitive. If there is an outside noise source, turning the whole machine 90 degrees may de-tune the interference.
7. Another Individual wearing a transmitter within 3' of your machine's console.

If you continue to experience problems contact your dealer.

HEART RATE PROGRAM OPERATION

Note: You must wear the heart rate transmitter strap for these programs

Both programs operate the same, the only difference is that **HR1** is set to 60% and **HR2** is set to 80% of the maximum heart rate. They both are programmed the same way.

To start an HR program follow the instructions below or just select the **HR1** or **HR2** program, then the Enter button and follow the directions in the **Message Center**.

After selecting your heart rate target the program will attempt to keep you at or within 3-5 heart beats per minute of this value. Follow the prompts in the **Message Center** to maintain your selected heart rate value.

1. Press the **HR 1** or **HR 2** key then press the **Enter** key.
2. The **Message Center** will ask you to enter your **Age**. You may enter your age, using the **Level Up** and **Down** keys, then press the **Enter** key to accept the new value and proceed on to the next screen.
3. You are now asked to enter your **Weight**. You may adjust the weight value using the **Level Up** and **Down** keys, then press **Enter** to continue.
4. Next is **Time**. You may adjust the time and press **Enter** to continue.
5. Now you are asked to adjust the **Heart Rate Target**. This is the heart rate level you will strive to maintain during the program. Adjust the level using the **Level Up** and **Down** keys, then press **Enter**. Note: The heart rate that appears is based on the % you accepted in Step 1. If you change this number it will either increase or decrease the % from Step 1.
6. Now you are finished editing the settings and can begin your workout by pressing the **Start** key. You can also go back and modify your settings by pressing the **Enter** key. *NOTE: At any time during the editing of Data you can press the Enter key to go back one screen.*
7. If you want to increase or decrease the workload at any time during the program press the **Level Up** or **Down** key. This will allow you to change your target heart rate at any time during the program.
8. During the **HR 1** or **HR 2** programs you will be able to scroll through the data in the **Message Center** by pressing the **Enter** key.
9. When the program ends you may press **Start** to begin the same program again or **Stop** to exit the program or you can save the program you just completed as a custom user program by pressing a **User** key and following the instructions in the **Message Center**.

GENERAL MAINTENANCE

1. Wipe down all areas in the sweat path with a damp cloth after each workout.
2. If a squeak, thump, clicking or rough feeling develops the main cause is most likely one of two reasons:
 - I. i. The hardware was not sufficiently tightened during assembly. All bolts that were installed during assembly need to be tightened as much as possible. It may be necessary to use a larger wrench than the one provided if you cannot tighten the bolts sufficiently. I cannot stress this point enough; 90% of calls to the service department for noise issues can be traced to loose hardware or the rear rails being dirty.
 - II. ii. Dirt build-up on the rear rails and polyurethane wheels are also a source of noise. Noise from build-up on the rails can cause a thumping sound that you would swear is coming from inside the main body of the machine because noise travels, and is amplified, in the tubing of the frame. Clean the rails and wheels with a lint free cloth and rubbing alcohol. Stubborn build-up can be removed with your thumbnail or a non-metallic scraper, like the back edge of a plastic knife. After cleaning, apply a small amount of lubricant on the rails with your fingers or a lint free cloth. You only need a thin coat of lubrication, wipe off any excess.
3. If squeaks or other noises persist, check that the unit is properly leveled. There are 4 leveling pads on the bottom of the rear rails, use a 14mm wrench (or adjustable wrench) to adjust the levelers.

MAINTENANCE MENU IN CONSOLE SOFTWARE

The console has built in maintenance/diagnostic software. The software will allow you to change the console settings from English to Metric and turn off the beeping of the speaker when a key is pressed for example. To enter the Maintenance menu (may be called Engineering mode, depending on version) press and hold down the **Start**, **Stop** and **Enter** keys. Keep holding the keys down for about 5 seconds and the message center will display ALTXXXX Engineering mode. Press the **Enter** button to access the menu below:

- a. **Key Test** (will allow you to test all the keys to make sure they are functioning)
- b. **LCD Test** (tests all the display functions)
- c. **Functions** (Press Enter to access settings and Up arrow to scroll)
 - i. **Sleep Mode** (Turn on to have the console power down automatically after 20 minutes of inactivity)
 - ii. **Pause Mode** (Turn on allow 5 minutes of pause, turn off to have the console pause indefinitely)
 - iii. **ODO Reset** (reset the odometer)
 - iv. **Units** (Sets the display to readout in English or Metric display measurements)
 - v. **Beep** (Turns off the speaker so no beeping sound is heard)
 - vi. **Motor Test** (Press enter to run the resistance motor up and down in a continuous loop. Display shows level setting and position sensor reading. Press stop to end test.)
 - vii. **Unit Type** (Should show E-Glide, other setting is elliptical. Switches calorie formula, HR program settings and watt tables for the different units)
 - viii. **Incline On/Off** (For E-Glide this is always off)
- d. **Security** (Allows the keypad to be locked to prevent unauthorized use)

MANUFACTURER'S LIMITED WARRANTY

ELLIPTICAL WARRANTY - Effective September 15, 2010

Spirit Fitness Inc. warrants all its elliptical parts for a period of time listed below from the date of retail sale, as determined by sale receipt, or in the absence of a sales receipt eighteen (18) months from the original factory shipping date. Spirit's responsibilities include providing new or remanufactured parts, at Spirit's option, and technical support to our independent dealers and servicing organizations. In the absence of a dealer or service organization, these warranties will be administered by Spirit Fitness directly to a consumer. The warranty period applies to the following components:

Warranty

Frame	Brake	Parts	Labor
Lifetime	Lifetime	10 Years	1 Year

NORMAL RESPONSIBILITIES OF THE CONSUMER

This warranty applies only to products in ordinary household use, and the consumer is responsible for the items listed below:

1. The warranty registration card must be completed and returned to the address listed on the card within 10 days of the original purchase to validate the manufacturer's limited warranty.
2. Proper use of the elliptical in accordance with the instructions provided in this manual
3. Proper installation in accordance with instructions provided with the elliptical and with all local electric codes.
4. Proper connection to a grounded power supply of sufficient voltage, replacement of blown fuses, repair of loose connections or defects in house wiring.
5. Expenses for making the elliptical accessible for servicing, including any item that was not part of the elliptical at the time it was shipped from the factory.
6. Damages to the elliptical finish during shipping, installation or following installation.
7. Routine maintenance of this unit as specified in this manual.

EXCLUSIONS

This warranty does not cover the following:

1. CONSEQUENTIAL, COLLATERAL, OR INCIDENTAL DAMAGES SUCH AS PROPERTY DAMAGE AND INCIDENTAL EXPENSES RESULTING FROM ANY BREACH OF THIS WRITTEN OR ANY IMPLIED WARRANTY.
Note: Some states do not allow the exclusion or limitation of incidental or consequential damages, so this limitation or exclusion may not apply to you.
2. Service call reimbursement to the consumer. Service call reimbursement to the dealer that does not involve malfunction or defects in workmanship or material, for units that are beyond the warranty period, for units that are beyond the service call reimbursement period, for elliptical not requiring component replacement, or elliptical not in ordinary household use.
3. Damages caused by services performed by persons other than authorized Spirit Fitness service companies; use of parts other than original Spirit parts; or external causes such as corrosion, discoloration of paint or plastic, alterations, modifications, abuse, misuse, accident, improper maintenance, inadequate power supply, or acts of God.
4. Products with original serial numbers that have been removed or altered.
5. Products that have been: sold, transferred, bartered, or given to a third party.
6. Products that do not have a warranty registration card on file at Spirit Fitness Inc. Spirit Fitness reserves the right to request proof of purchase if no warranty record exists for the product.
7. THIS WARRANTY IS EXPRESSLY IN LIEU OF ALL OTHER WARRANTIES EXPRESSED OR IMPLIED, INCLUDING THE WARRANTIES OF MERCHANTABILITY AND/OR FITNESS FOR A PARTICULAR PURPOSE.
8. Product use in any environment other than a residential setting.
9. Warranties outside of North America may vary. Please contact your local dealer for details.

SERVICE

Keep your bill of sale. Twelve (12) months from the date on the bill of sale or eighteen (18) months from the date of factory shipping as determined by the serial number establishes the labor warranty period should service be required. If service is performed, it is in your best interest to obtain and keep all receipts. This written warranty gives you specific legal rights. You may also have other rights that vary from state to state. Service under this warranty must be obtained by following these steps, in order:

1. Contact your selling authorized Spirit Fitness dealer. OR
2. Contact your local authorized Spirit Fitness service organization.
3. If there is a question as to where to obtain service, contact our service department at (870) 935-1107.
4. Spirit's obligation under this warranty is limited to repairing or replacing, at Spirit's option, the product through one of our authorized service centers. All repairs must be preauthorized by Spirit. If the product is shipped to a service center freight charges to and from the service center will be the customer's responsibility. For replacement parts shipped while the product is under warranty, the customer will be responsible for shipping and handling charges. For in-home service, the customer will be responsible for a trip charge. There will be an additional trip charge if the customer is located over 100 miles from the nearest service center.
5. The owner is responsible for adequate packaging upon return to Spirit. Spirit is not responsible for damages in shipping. Make all freight damage claims with the appropriate freight carrier. DO NOT SHIP ANY UNIT TO OUR FACTORY WITHOUT A RETURN AUTHORIZATION NUMBER. All units arriving without a return authorization number will be refused.
6. For any further information, or to contact our service department by mail, send your correspondence to:

Spirit Fitness, Inc.
P.O. Box 2037
Jonesboro, AR 72402-2037

Product features or specifications as described or illustrated are subject to change without notice. All warranties are made by Spirit Fitness, Inc. This warranty applies only in the 50 states of the U.S.A.